

(E)

SEE NOTE 201  
28A, 28B, 28C & 28D TYPING UNITS

R  
TYPING UNIT CONN.  
(20 PINS)

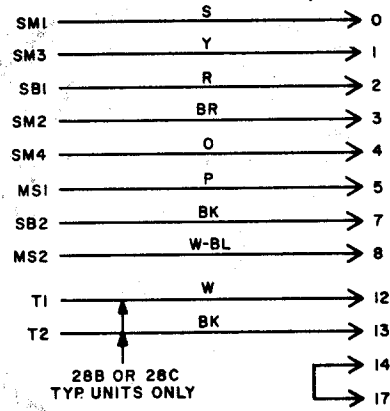

SM  
SELECTOR MAGNETS

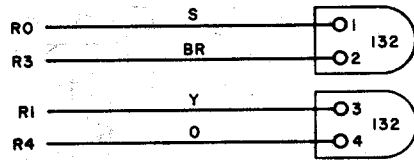

SB  
SIGNAL BELL CONT.

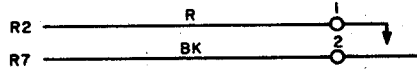

MS  
MOTOR CONTROL CONT.

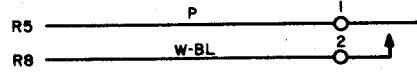

T  
TABULATION CONTACTS  
28B OR 28C TYP. UNIT ONLY

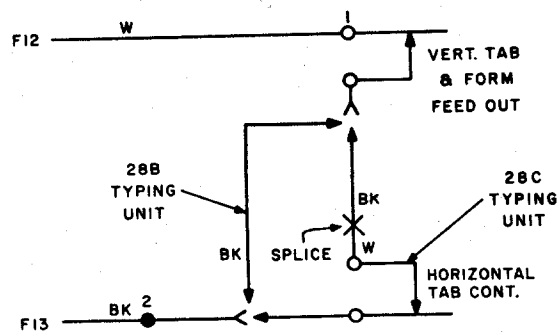

(A)

SEE NOTE 202  
28D TELETYPEWRITER BASE

F  
KEYBOARD CONN.  
(20 PINS)

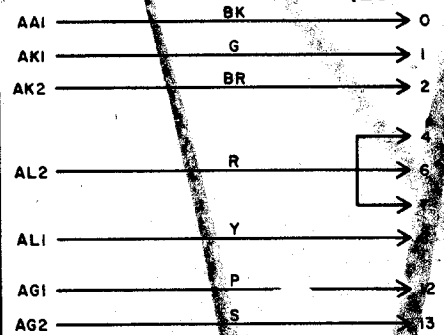

G  
MOTOR T. B.

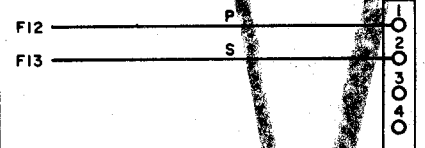

AA  
KEYBOARD SIGNAL GE

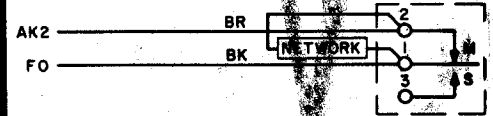

AK  
SIGNAL LINE  
BREAK KEY SWITCH

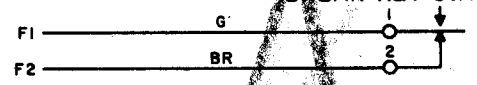

AL  
MARGIN INDR. SW



2  
TER BASE

F  
BOARD CONN.  
20 PINS



G  
R T. B.

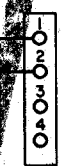

AA  
RD SIGNAL GEN.

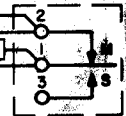

AK  
GNAL LINE  
K KEY SWITCH

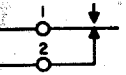

AL  
GIN INDR. SW.

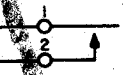

(B)  
SEE NOTE 202  
28B TELETYPEWRITER BASE

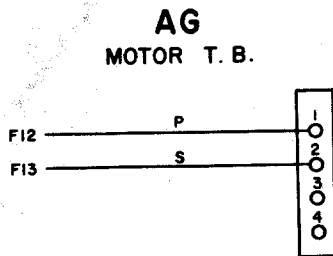
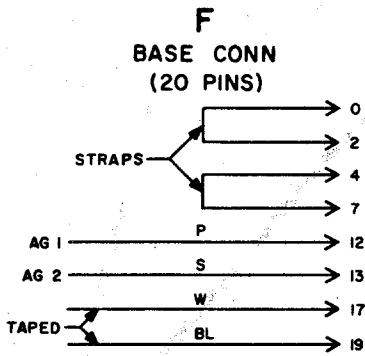

28A MOTOR UNIT

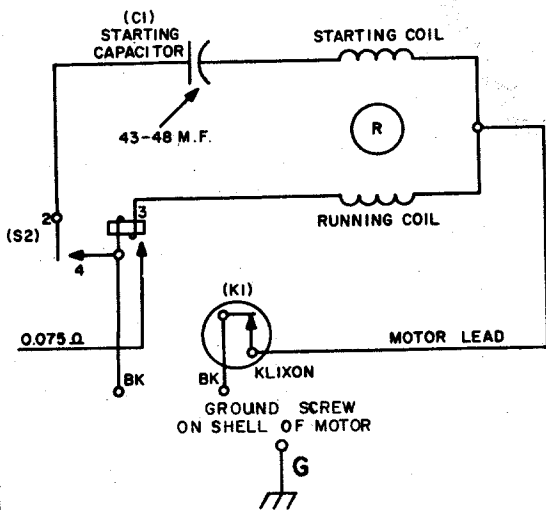

(G)

K  
TP 152625 LINE TEST KEY  
ASSEMBLY

NOTE: REMOVE STRAPS FROM B1 TO B2 & B8 TO B9

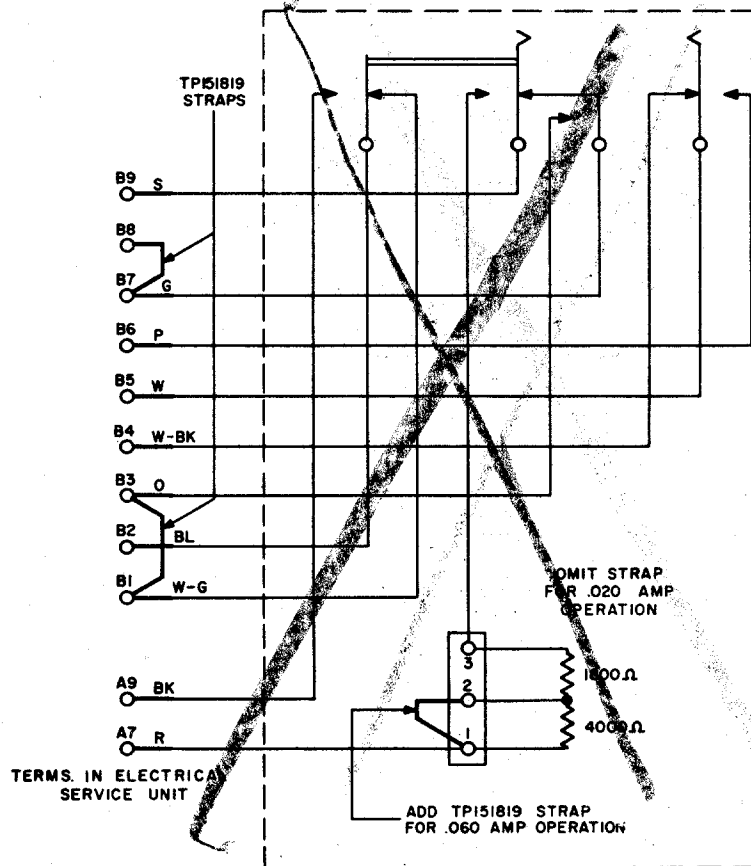

(F)

SEE NOTE 201

### MODIFICATION & WIRING FOR SELECTIVE CALLING 28E, 28F & 28G TYPING UNITS

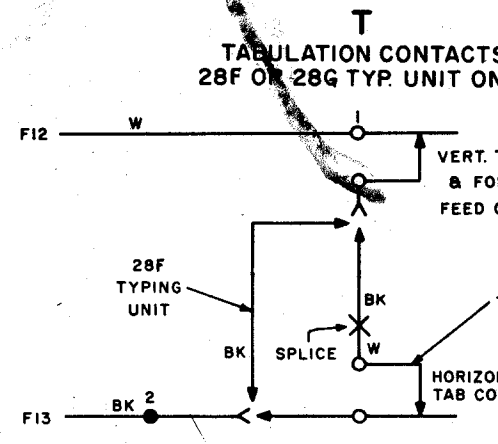
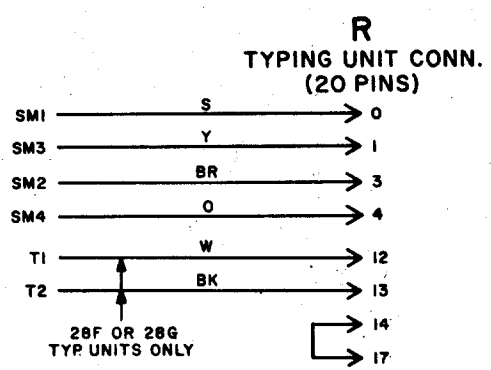
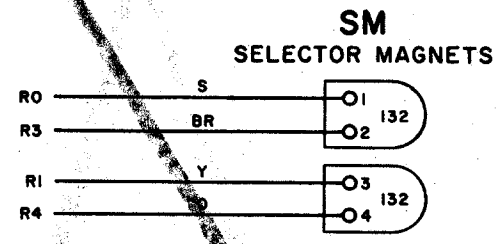
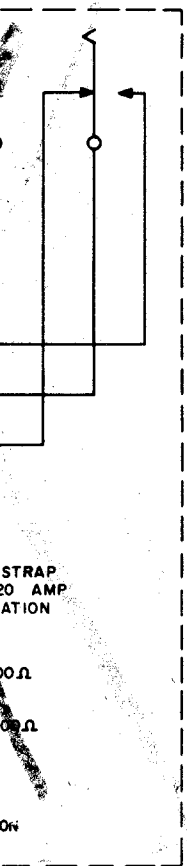
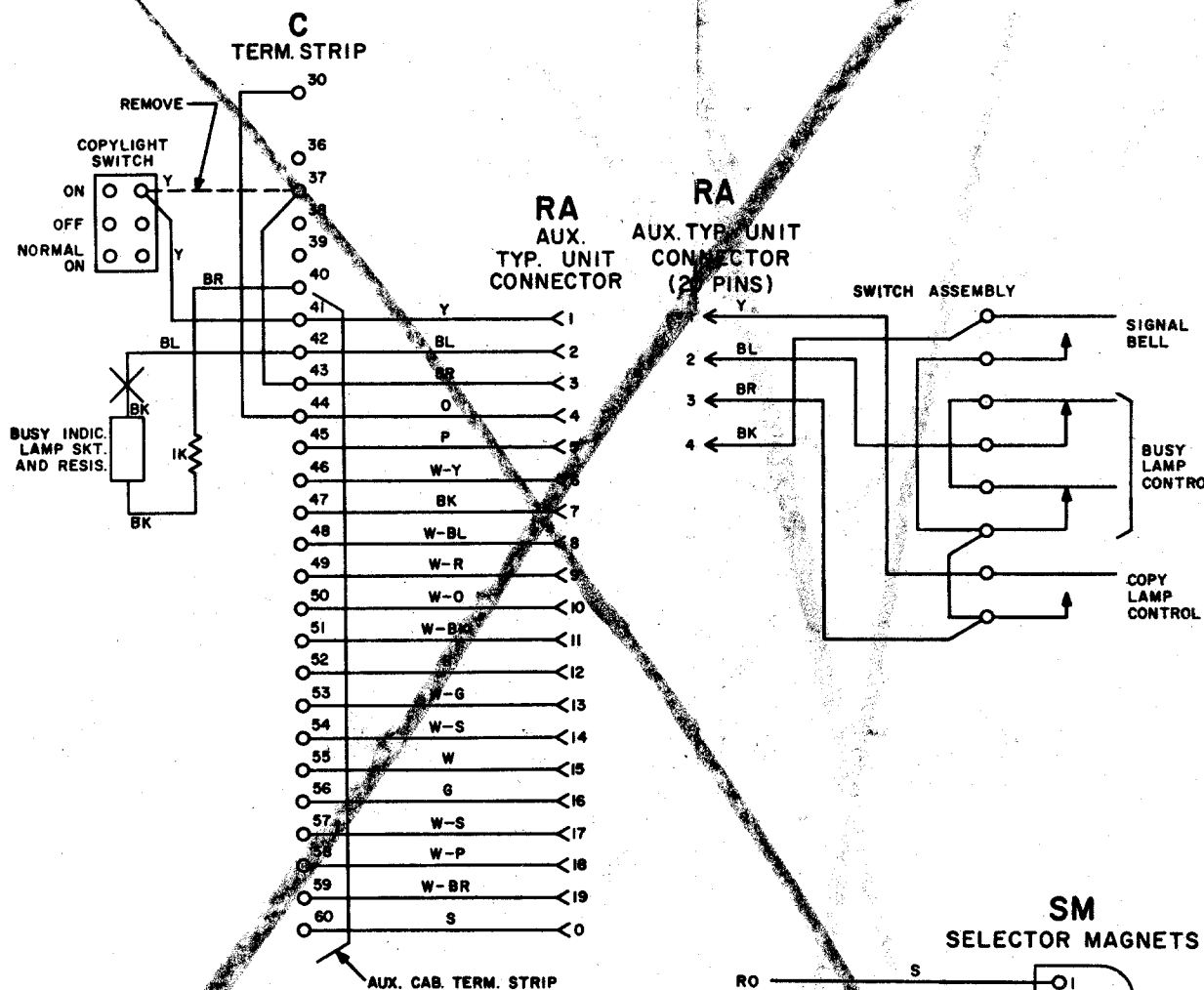

(H)

TIME SWITCH

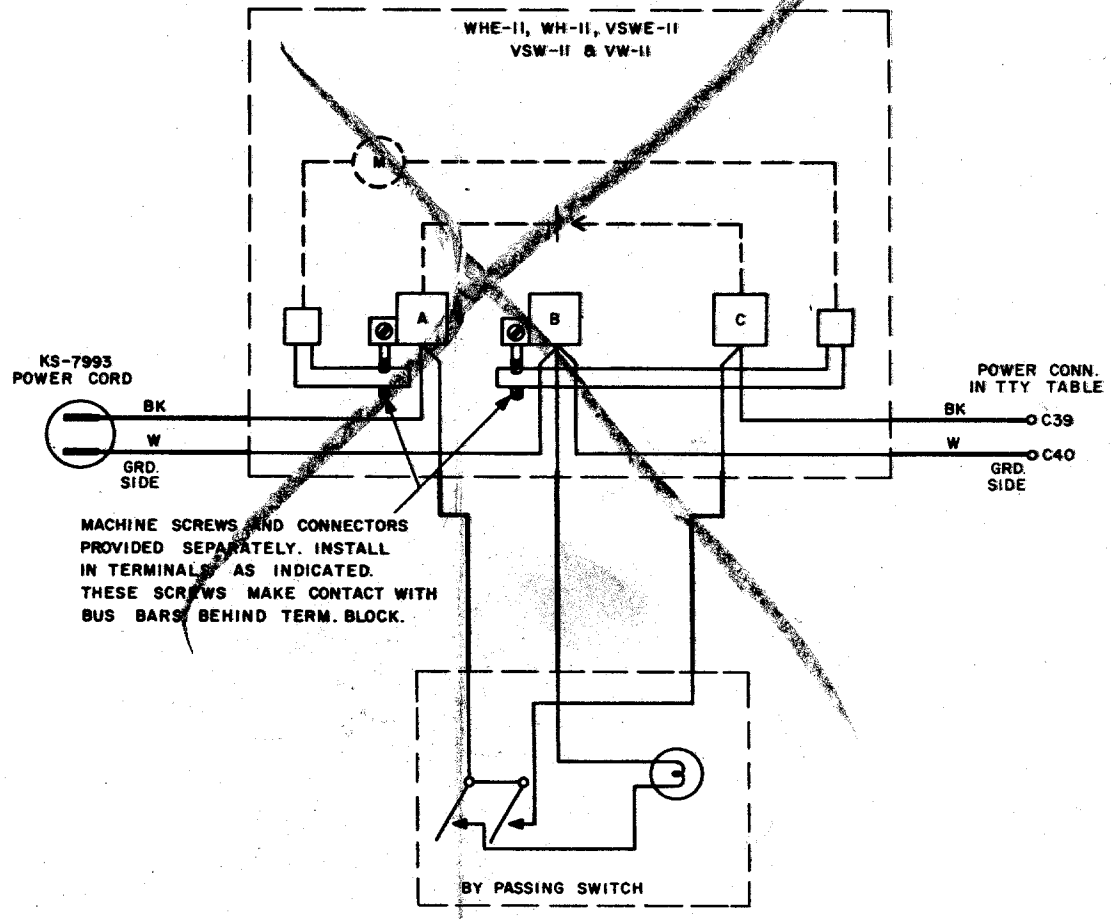

MACHINE SCREWS AND CONNECTORS PROVIDED SEPARATELY. INSTALL IN TERMINALS AS INDICATED. THESE SCREWS MAKE CONTACT WITH BUS BARS BEHIND TERM. BLOCK.

NG

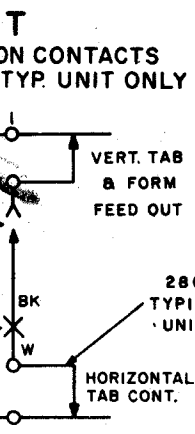
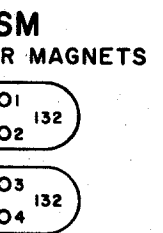
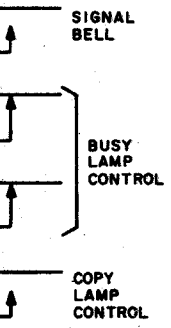

WESTERN ELECT  
 Product Engineer  
 Teletype Corpora  
 WO  
 28 TYPE T  
 KEYBOARD SEND-REC  
 LINE RELAY -  
 NEUTRAL OR POL  
 SHE  
 TP-581.000

W0470  
SHEET C2

(H)

### TIME SWITCH

WHE-II, WH-II, VSWE-II  
VSW-II & VW-II

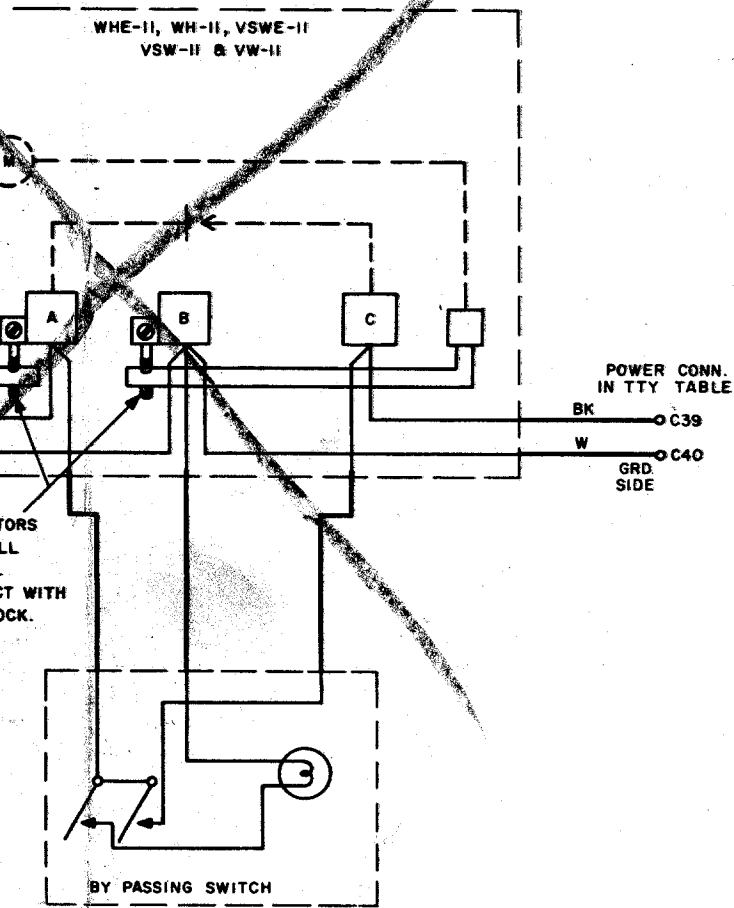

### DRAWING ISSUE

| ISSUE | DATE     | SIGN. |
|-------|----------|-------|
| 1     | 11-15-63 | EHT   |

WESTERN ELECTRIC COMPANY, INC.

Product Engineering Control Center  
Teletype Corporation

W0470

28 TYPE TWPL SERVICE  
KEYBOARD SEND-RECEIVE OR RECEIVE-ONLY  
LINE RELAY - SWITCH CONTROL  
NEUTRAL OR POLAR - AC 60 CYCLES

SHEET C2

TP-581.000

FILE IN BOOK 4C